

Single lamp, solid state light engine recessed floor washer. Used for low level lighting of steps and paths and wayfinding in residential, institutional, commercial and theater applications. May be used indoors or out.

## SPECIFICATIONS

### HOUSING

- Aluminum trim. Precision die formed back box with integral screed edge for sheetrock or flange for use in all other materials.

### MOUNTING

- Recessed in drywall or sheetrock

### ELECTRICAL

- Backbox with integral junction box suitable for through wiring
- Triac dimming available- line voltage

### LAMP

- 4W LED supplied with fixture

### SOCKET

- Sealed and potted integral to trim

### LENS

- Satin acrylic lens. Optional color lenses available

### TRIM

- Flangeless or flanged die-cast aluminum snap-in trapezoidal louvered aperture

### FINISH

- Aperture trim available in black, white or aluminum as standard
- Additional colors and RAL palette available
- Consult factory for custom finishes

### LABELS

-  , US tested to UL standards 1598, Wet location

**JOB:** \_\_\_\_\_

**SPECIFIER:** \_\_\_\_\_

**TYPE:** \_\_\_\_\_

**QUANTITY:** \_\_\_\_\_

**SIGNATURE:** \_\_\_\_\_

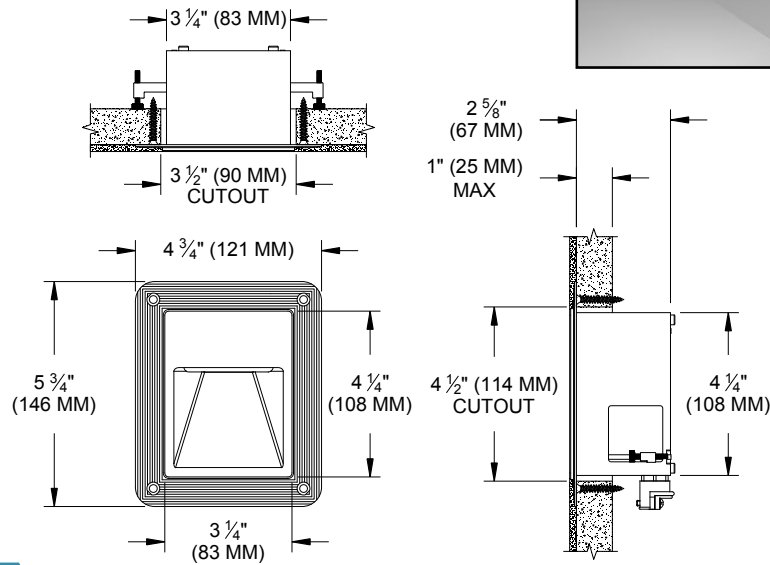

PLASTER HOUSING

## ORDERING INFORMATION

2102-LED-PH	SOURCE	VOLTAGE	TRIM FINISH	APERTURE LENS
		120v		79A
Plaster Housing 9= 90+CRI 27 = 2700K 30 = 3000K 35 = 3500K 40 = 4000K	4W = 4W 4WDM = 4W (Triac Dim)	120v	P14 = White BLK=Black PXX = SLI Color XXXX = RAL # CST = Custom	79A = Veiling Acrylic



Patent Pending.  
These specifications subject to change without notice.

[www.specialtylightingindustries.com](http://www.specialtylightingindustries.com)  
1306 Doris Avenue, Ocean, NJ 07712 USA  
800.462.7812 732.517.0800 FAX:732.517.0971