

SNAP

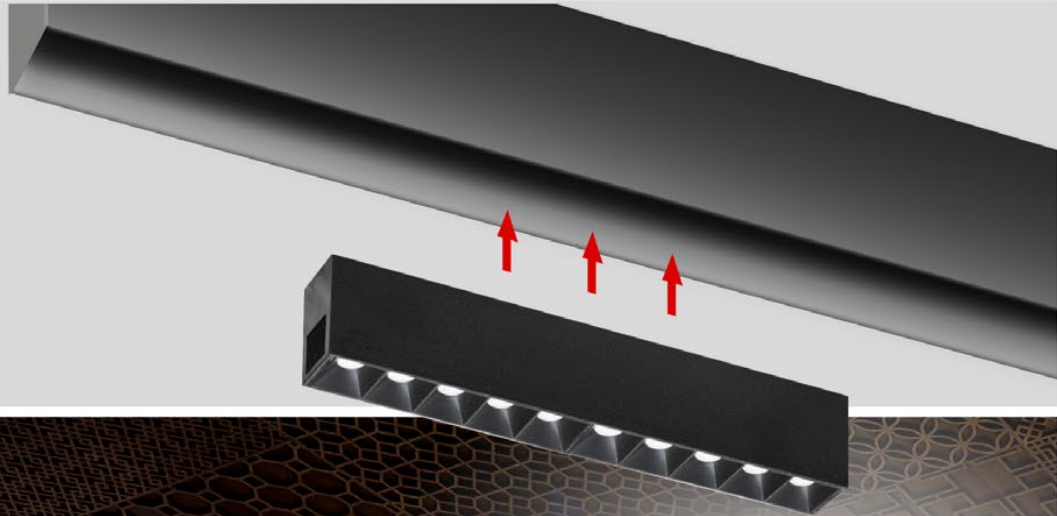

SLI Table of Contents

Point Source (Adjustable / Fixed)	2-3
Point Source (Multi-Adjustable)	4
Point Source (Wall Wash / Mini)	4-5
SNAP (Modular)	6
Linear (Wall Wash)	7
Linear (Wall Grazer)	8
Linear (General)	9
Wood (Custom trims)	10-11
Cylinders / HUSH-3	12
Specialty Lights	13
Point Source (Uplights / Step)	14
Point Source (Picture / Cylinder)	15

flawless.

SERIES

ADJUSTABLE/FIXED

SLI's 1000 Series Adjustable point source accent fixtures are adjustable 365° on the horizontal plane and up to 45° on the vertical plane. Ideal for accenting areas along walls or centerpiece objects.

SLI's 4000 Series Fixed point source general downlight fixtures are fixed lights ideal for illuminating larger areas

Check below for the availability of the following housing types: Housings for the round trims come with separate collars for plaster or standard ceilings. UH Standard housing for all ceilings (for use with the ZT or FT trim); CUH Compact housing for all ceilings (for use with the ZT or FT trim); SUH Shallow housing for all ceilings (for use with the ZT or FT trim); AUH IC rated, Airtight housing for all ceilings (for use with the FT trim). Available for wet location with ST trim and IC/Airtight.

FLAT



1000 / 4000

Round, single LED point source fixtures are available with many different light sources. Nominal 4" (102mm) diameter flat trim with 2" aperture and optional glass diffuser.

Interchangeable reflector provides multiple beam patterns. Optional borosilicate lenses available for aperture.

LAMP OPTIONS: Citizen, Xicato, AmbientDim®, MR-16, MR-16 CMH, Soraa, Lumenetix, AR111

HOUSING TYPES: UH Universal, Airtight Universal, Shallow, Chicago Plenum and IC.

CONICAL

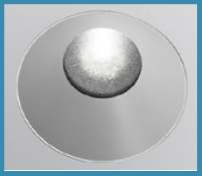

1001 / 4001

Round, single LED point source fixtures are available with many different light sources. Nominal 4" (102mm) conical trim with 2" aperture and optional glass diffuser. Interchangeable reflector provides multiple beam patterns. Optional borosilicate lenses available for aperture.

Interchangeable reflector provides multiple beam patterns. Optional borosilicate lenses available for aperture.

LAMP OPTIONS: Citizen, Xicato, AmbientDim®, MR-16, MR-16 CMH, Soraa, Lumenetix, AR111

HOUSING TYPES: UH Universal, Airtight Universal, Shallow, Chicago Plenum and IC.

BOX

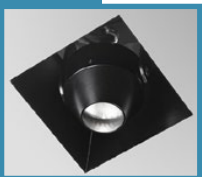

1005

The 1005 series LED point source fixtures yield maximum adjustability in an open square or trough application. The 1005 can be a single lamp or multiple lamp linear slot. Dual lamp, LED/low-voltage halogen, recessed, open slot accent light with nominal 4"x4", 6"x6", 8"x8", 4"x8", 4"x12", or custom rectilinear trim options.

LAMP OPTIONS: Citizen, Xicato, AmbientDim®, MR-16, MR-16 CMH, Soraa, AR111

HOUSING TYPES: PH/ APH plaster, UH/AUH universal and Flanged.

BEVEL



1009 / 4009

Square, single LED point source fixtures are available with many different light sources. Nominal 4" square trim and optional glass diffuser. Interchangeable reflector provides multiple beam patterns. Optional borosilicate lenses available for aperture.

LAMP OPTIONS: Citizen, Xicato, AmbientDim®, MR-16, MR-16 CMH, Soraa, Lumenetix, AR111

HOUSING TYPES: PH Plaster, SPH Shallow plaster flange, APH Airtight plaster flange, UH Universal, SUH Shallow universal, AUH Airtight universal, compact, Chicago Plenum, surface and IC.

BEVEL



1009-2 / 4009-2

Rectangular, 2-lamp LED point source fixture are available with many different light sources. Nominal 4"x9" rectangular trim and optional glass diffuser. Interchangeable reflector provides

multiple beam patterns. Optional borosilicate lenses available for aperture.

LAMP OPTIONS: Citizen, Xicato, AmbientDim®, MR-16, MR-16 CMH, Soraa, Lumenetix, AR111

HOUSING TYPES: PH Plaster, SPH Shallow plaster flange, APH Airtight plaster flange, UH Universal, SUH Shallow universal, AUH Airtight universal, IC.

BEVEL



1009-3 / 4009-3

Rectangular, 3-lamp LED point source fixtures are available with many different light sources. Nominal 4"x13.5" (102mm x 343mm) rectangular trim and flangeless trim. Interchangeable reflector

provides multiple beam patterns. Optional borosilicate lenses available for aperture.

LAMP OPTIONS: Citizen, Xicato, AmbientDim®, MR-16, MR-16 CMH, Soraa, Lumenetix, AR111

HOUSING TYPES: PH Plaster, SPH Shallow plaster flange, APH Airtight plaster/LED flange, UH Universal, SUH Shallow universal, AUH Airtight universal/LED, IC/LED.

BEVEL

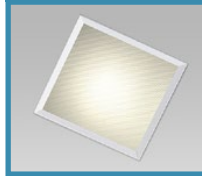

1010 / 4010

Square, single LED point source fixtures are available with many different light sources. Nominal 4" square trim, flanged or flangeless trim and optional glass diffuser. Interchangeable reflector

provides multiple beam patterns. Optional borosilicate lenses available for aperture.

LAMP OPTIONS: Citizen, Xicato, AmbientDim®, MR-16, MR-16 CMH, Soraa, Lumenetix, AR111

HOUSING TYPES: PH Plaster, SPH Shallow plaster, APH Airtight plaster, UH Universal, SUH Shallow, AUH Airtight universal, Chicago Plenum, surface and IC.

FLAT

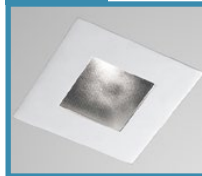

1012 / 4012

Square, single lamp LED point source fixtures are available with many different light sources. Nominal 4" flat square trim, flanged or flangeless trim and optional glass diffuser. Interchangeable

reflector provides multiple beam patterns. Optional borosilicate lenses available for aperture.

LAMP OPTIONS: Citizen, Xicato, AmbientDim®, MR-16, MR-16 CMH, Soraa, Lumenetix, AR111

HOUSING TYPES: PH Plaster, SPH Shallow plaster, APH Airtight plaster, UH Universal, SUH Shallow, AUH Airtight universal, Chicago Plenum, surface and IC.

BEVEL

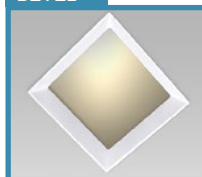

1014 / 4014

Square, single lamp LED point source fixtures are available with many different light sources. Nominal 4" beveled trim, flanged or flangeless trim and optional glass diffuser. Interchangeable reflector

provides multiple beam patterns. Optional borosilicate lenses available for aperture.

LAMP OPTIONS: Citizen, Xicato, AmbientDim®, MR-16, MR-16 CMH, Soraa, Lumenetix, AR111

HOUSING TYPES: PH Plaster, SPH Shallow plaster, APH Airtight plaster, UH Universal, SUH Shallow, AUH Airtight universal, Chicago Plenum, surface and IC.

NOTE: These specifications are subject to change without notice



BEVEL

1014-2 / 4014-2

Rectangular, 2-lamp LED point source fixture are available with many different light sources.

Nominal 4"x 9" rectangular trim and optional glass diffuser. Interchangeable reflector provides multiple beam patterns. Optional borosilicate lenses available for aperture.

LAMP OPTIONS: Citizen, Xicato, AmbientDim®, MR-16, MR-16 CMH, Soraa, Lumenetix, AR111

HOUSING TYPES: PH Plaster, SPH Shallow plaster flange, APH Airtight plasterange, UH Universal, SUH Shallow universal, AUH Airtight universal, IC.



BEVEL

1014-3 / 4014-3

Rectangular, 3-lamp LED point source fixtures are available with many different light sources. Nominal 4"x13.5" (102mm x 343mm) rectangular trim and flangeless trim. Interchangeable reflector provides multiple beam patterns. Optional borosilicate lenses available for aperture.

LAMP OPTIONS: Citizen, Xicato, AmbientDim®, MR-16, MR-16 CMH, Soraa, Lumenetix, AR111

HOUSING TYPES: PH Plaster, SPH Shallow plaster flange, APH Airtight plaster/LED flange, UH Universal, SUH Shallow universal, AUH Airtight universal/LED, IC/LED.



CONICAL

1016 / 4016

Round, single LED point source fixtures are available with many different light sources. Nominal 4" (102mm) conical trim with 3" aperture and optional glass diffuser. Interchangeable reflector provides multiple beam patterns. Optional borosilicate lenses available for aperture.

LAMP OPTIONS: Citizen, Xicato, AmbientDim®, MR-16, MR-16 CMH, Soraa, Lumenetix, AR111

HOUSING TYPES: UH Universal, Airtight Universal, Shallow, Chicago Plenum and IC.



BEVEL

1017 / 4017

Square, single lamp LED point source fixtures are available with many different light sources. Nominal 4" square trim, flanged or flangeless trim and optional glass diffuser. Interchangeable reflector provides multiple beam patterns. Optional borosilicate lenses available for aperture.

LAMP OPTIONS: Citizen, Xicato, AmbientDim®, MR-16, MR-16 CMH, Soraa, Lumenetix, AR111

HOUSING TYPES: PH Plaster, SPH Shallow plaster, APH Airtight plaster, UH Universal, SUH Shallow universal, AUH Airtight universal, Chicago Plenum, surface, compact and IC.



CYLINDER

NEW! 1018

Cylinder, single lamp LED point source fixtures with 4" (50mm) housing and conical trim. Stackable options with Long Snoot and surface mounted junction box. Modular housing allow for 360° rotation along the horizontal plane and 90° rotation across the vertical.

LAMP OPTIONS: Citizen, AmbientDim®

HOUSING TYPES: SH Surface housing.



FLAT

1020 / 4020

Round, single lamp LED point source fixtures with nominal 6" (152mm) flat trim and 4" light aperture and optional glass diffuser. Interchangeable reflector provides multiple beam patterns. Optional borosilicate lenses available for aperture.

LAMP OPTIONS: Citizen, Xicato, AmbientDim®, MR-16, MR-16 CMH, Soraa, Lumenetix, AR111

HOUSING TYPES: UH Universal, Airtight Universal, Shallow, Chicago Plenum and IC.



CONICAL

1021 / 4021

Round, single lamp LED point source fixtures with nominal 6" (152mm) conical trim and 4" aperture and optional glass diffuser. Interchangeable reflector provides multiple beam patterns.

Optional borosilicate lenses available for aperture.

LAMP OPTIONS: Citizen, Xicato, AmbientDim®, MR-16, MR-16 CMH, Soraa, Lumenetix, AR111

HOUSING TYPES: UH Universal, Airtight Universal, Shallow, Chicago Plenum and IC.



BEVEL

1029 / 4029

Square, single lamp LED point source fixtures are available with many different light sources. Nominal 6" square trim, flanged or flangeless trim and optional glass diffuser. Interchangeable reflector provides multiple beam patterns. Optional borosilicate lenses available for aperture.

LAMP OPTIONS: Citizen, Xicato, AmbientDim®, MR-16, MR-16 CMH, Soraa, Lumenetix, AR111

HOUSING TYPES: PH Plaster, SPH Shallow plaster, APH Airtight plaster, UH Universal, SUH Shallow universal, AUH Airtight universal, Chicago Plenum, surface, compact and IC.

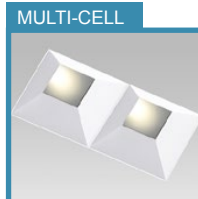

MULTI-CELL

1050-2/3 / 4050-2/3

2, 3, or Quad cell point source fixtures are available with many different light sources. Nominal 4"x 8" (102mm x 203mm), 4"x12" linear or 8"x8" square cell flangeless trim. Clear pyrex safety lens. Optional borosilicate lenses available for lamp holder and aperture. Suitable for install from below applications.

LAMP OPTIONS: Citizen, Xicato, AmbientDim®, MR-16, MR-16 CMH, Soraa, Lumenetix, AR111

HOUSING TYPES: PH Plaster, SPH Shallow plaster flange, APH Airtight plaster, UH Universal, SUH Shallow universal, AUH Airtight universal, IC.

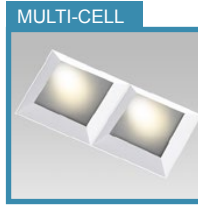

MULTI-CELL

1057-2/3 / 4057-2/3

Dual cell point source fixtures are available with many different light sources. Nominal 4"x 8" (102mm x 203mm) flangeless trim. Clear pyrex safety lens. Optional borosilicate lenses available for lamp holder and aperture. Suitable for install from below applications.

LAMP OPTIONS: Citizen, Xicato, AmbientDim®, MR-16, MR-16 CMH, Soraa, Lumenetix, AR111

HOUSING TYPES: PH Plaster, SPH Shallow plaster flange, APH Airtight plaster, UH Universal, SUH Shallow universal, AUH Airtight universal, IC.

SERIES POINT SOURCE MULTIPLE ADJUSTABLE

Multi-lamps provide better solutions for configuring light sources in different positions. SLI's Multiple Series allow accent lighting of more than one area. Accent a wall and accent a floor. The ability to have 2 lamps that can be adjusted in different directions increase lighting options.

FLAT

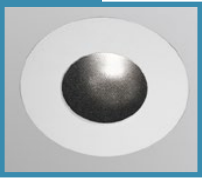

1000M MULTI-LAMP

Multiple lamp (each fully adjustable) single aperture, LED or low-voltage halogen, recessed accent lights, nominal 4" (100mm) diameter flat trim with 2" (50mm) aperture and optional glass diffuser.

LAMP OPTIONS: Citizen, AmbientDim, MR-16, MR-16 CMH, Soraa

HOUSING TYPES: UH Universal, Airtight Universal, Shallow, Chicago Plenum and IC.

CONICAL

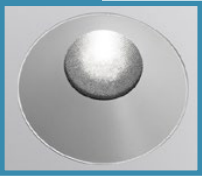

1001M MULTI-LAMP

Multiple lamp, LED or low-voltage halogen, recessed accent lights with nominal 4" (100mm) conical trim with 2" aperture and optional glass diffuser. Clear pyrex safety lens. Optional borosilicate lenses available for lampholder and aperture.

LAMP OPTIONS: Citizen, AmbientDim, MR-16, MR-16 CMH, Soraa

HOUSING TYPES: UH Universal, Airtight Universal, Shallow, Chicago Plenum and IC.

BEVEL



1009M MULTI-LAMP

The 1009 series accent light yields maximum adjustability in an open square or trough application. Multiple lamp, low-voltage halogen, recessed accent light with nominal 6" (159mm) or 4" square aperture and optional glass diffuser. Dimmable options. Optional borosilicate lenses available for lampholder and aperture.

LAMP OPTIONS: Citizen, AmbientDim, MR-16, MR-16 CMH, Soraa

HOUSING TYPES: PH Plaster, APH Airtight plaster flange, UH Universal, AUH Airtight universal, Chicago Plenum, and IC.

FLAT

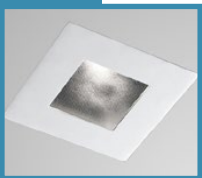

1012M MULTI-LAMP

The square point source accent fixtures are available with many different light sources. Multiple lamp, low-voltage halogen, recessed accent light with nominal 2" square aperture, flangeless trim and optional glass diffuser. Clear pyrex safety lens. Optional borosilicate lenses available for lamp holder and aperture.

LAMP OPTIONS: Citizen, AmbientDim, MR-16, MR-16 CMH, Soraa

HOUSING TYPES: PH/ APH plaster, UH/AUH Airtight universal, Chicago Plenum, IC.

CONICAL

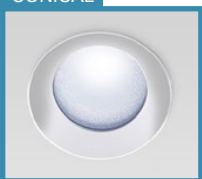

1016M MULTI-LAMP

The round point source accent fixtures are available with many different light sources. Multiple lamp, solid state light engine, recessed accent light with conical trim 3" (75mm) aperture and optional glass diffuser.

LAMP OPTIONS: Citizen, AmbientDim, MR-16, MR-16 CMH, Soraa

HOUSING TYPES: UH Universal, Airtight Universal, Shallow, Chicago Plenum and IC.

BEVEL

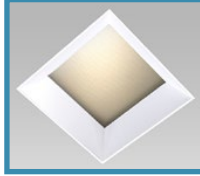

1017M MULTI-LAMP

The square point source accent fixtures are available with many different light sources. They are adjustable 365 degrees on the horizontal plane and up to 45 degrees on the vertical plane.

Multiple lamp, solid state light engine, recessed accent light with nominal 3" (75mm) square aperture and optional glass diffuser.

LAMP OPTIONS: Citizen, AmbientDim, MR-16, MR-16 CMH, Soraa

HOUSING TYPES: PH Plaster, APH Airtight plaster flange, UH Universal, AUH Airtight universal, Chicago Plenum, and IC.

SERIES POINT SOURCE MULTIPLE ADJUSTABLE (MDL)

MDL's provide increased space between lamps within a single housing. Available in numerous lamp configurations, Each MDL lamp can rotate and be aimed in a different direction to highlight surfaces in a room.

2MDL

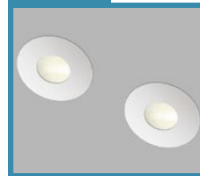

1000-2MDL / 4MDL

Multiple lamp (each fully adjustable) 2 or 4 aperture, LED or low-voltage halogen, recessed accent lights, nominal 4" (100mm) diameter flat trim with 2" (50mm) aperture and optional glass diffuser.

LAMP OPTIONS: Citizen, AmbientDim, MR-16, MR-16 CMH, Soraa

HOUSING TYPES: UH Universal, Airtight Universal, Shallow, Chicago Plenum and IC.

4MDL

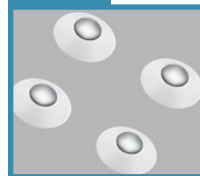

1001-2MDL / 4MDL

Multiple lamp (each fully adjustable) 2 or 4 aperture, LED or low-voltage halogen, recessed accent lights with nominal 4" (100mm) conical trim with 2" aperture and optional glass diffuser.

LAMP OPTIONS: Citizen, AmbientDim, MR-16, MR-16 CMH, Soraa

HOUSING TYPES: UH Universal, Airtight Universal, Shallow, Chicago Plenum and IC.

2MDL

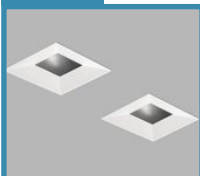

1009-2MDL / 4MDL

Multiple lamp (each fully adjustable) 2 or 4 aperture, LED or low-voltage halogen, recessed accent light with nominal 6" (159mm) or 4" square aperture and optional glass diffuser.

LAMP OPTIONS: Citizen, AmbientDim, MR-16, MR-16 CMH, Soraa

HOUSING TYPES: PH Plaster, APH Airtight plaster flange, UH Universal, AUH Airtight universal, Chicago Plenum, and IC.

NOTE: These specifications are subject to change without notice

1306 DORIS AVE. OCEAN, NJ 07712 USA
800.462.7812 | 732.517.0800 | F: 732.517.0971
© 2017 SpecialtyLighting Industries, Inc.

www.specialtylightingindustries.com

SERIES POINT SOURCE WALL WASHER

All of our wall washers are specification grade, can be built to specification. Wall washers provide clean, even and total coverage for applications that demand superior lighting.



1200

Dual lamp wall wash fixture is designed optically to flood the surface of the wall with light from the ceiling line to the floor. Low-voltage halogen recessed adjustable wall washer with nominal 5" x 5" and 5"x 7" aperture options and flangeless trim.

LAMP OPTIONS: Citizen, AmbientDim, MR-16, ALR12, Soraa

HOUSING TYPES: PH Plaster or FH Flange Housing



1240-2

The 1240-2 wall wash fixtures are designed optically to flood the surface of the wall with light from the ceiling line to the floor. They can be ordered to fit any ceiling system. Dual lamp fixture or single lamp compact fluorescent recessed wall washer or with nominal 4"x 9" rectilinear aperture.

LAMP OPTIONS: Citizen, Xicato, AmbientDim, MR-16, MR-16 CMH, Lumenetix, Soraa

HOUSING TYPES: PH Plaster, SPH Shallow plaster flange, APH Airtight plaster flange, UH Universal, SUH Shallow universal, AUH Airtight universal, compact, Chicago Plenum, surface and IC.



1240AW

Double lamp fixtures wash the wall with light from the ceiling line to the floor, and provide an additional adjustable accent light. Twin lamp, LED recessed combination wall washer and accent

light with nominal 4"x 8" rectangular 2 cell aperture and flangeless trim.

LAMP OPTIONS: Citizen, Xicato, AmbientDim, MR-16, MR-16 CMH, Lumenetix, Soraa

HOUSING TYPES: PH Plaster, SPH Shallow plaster flange, APH Airtight plaster flange, UH Universal, SUH Shallow universal, AUH Airtight universal, compact, Chicago Plenum, surface and IC.

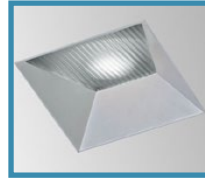

1240

The 1240-2 wall wash fixtures are designed optically to flood the surface of the wall with light from the ceiling line to the floor. They can be ordered to fit any ceiling system. Single lamp recessed wall washer with nominal 4" square aperture. Frosted supertex borosilicate spread lens, hinged for relamping.

LAMP OPTIONS: Citizen, Xicato, AmbientDim, MR-16, MR-16 CMH, Lumenetix, Soraa
HOUSING TYPES: PH Plaster, SPH Shallow plaster flange, APH Airtight plaster flange, UH Universal, SUH Shallow universal, AUH Airtight universal, compact, Chicago Plenum, surface and IC.



1240WW

These double lamp fixtures give you the ability to wash adjacent walls with light from the ceiling line to the floor. Twin lamp, LED recessed combination wall washer and accent light with nominal 4"x8" or 8"x9" rectangular 2 cell aperture and flangeless trim.

LAMP OPTIONS: Citizen, Xicato, AmbientDim, MR-16, MR-16 CMH, Lumenetix, Soraa

HOUSING TYPES: PH/SPH Plaster, UH/SUH (Universal), APH/AUH Airtight, CP

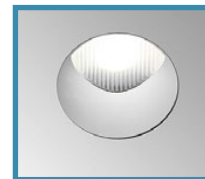

1250

The 1250 round wall wash fixture is designed optically to flood the surface of the wall with light from the ceiling line to the floor. They can be ordered to fit any ceiling system. Single lamp, recessed wall washer with nominal 4" diameter. Frosted supertex borosilicate spread lens, hinged for relamping.

LAMP OPTIONS: Citizen, Xicato, AmbientDim, MR-16, MR-16 CMH, Lumenetix, Soraa

HOUSING TYPES: PH Plaster, SPH Shallow plaster flange, APH Airtight plaster flange, UH Universal, SUH Shallow universal, AUH Airtight universal, compact, Chicago Plenum, surface and IC

SERIES POINT SOURCE MINI FIXED

SLI's point source mini-fixed down light is a small aperture lamp fixture. The lamp is aimed in a straight down position.

CONICAL



4500

True pinhole, fixed downlighting – with 2" round trims and various aperture options. Available in LED, low-voltage halogen, metal halide. Dimming and borosilicate lensing options

available as well as a decorative glass option.

LAMP OPTIONS: Citizen, Xicato, AmbientDim, MR-16, MR-16 CMH, Soraa, R14

HOUSING TYPES: CUH (Compact Universal), AUH (Airtight Universal), Retrofit – for use in all ceiling conditions including GWB plaster ceilings

CONICAL



4501

Fixed LED, down light with 2" round flanged or flangeless trim for use as retrofit.

LAMP OPTIONS: Citizen and Ambient Dim LED

HOUSING TYPES: Retrofit

BEVEL



4509

Single lamp, fixed downlighting – with 2.5" square trim and various aperture options. Flood aperture with low brightness parabolic reflector.

LAMP OPTIONS: Citizen, AmbientDim

HOUSING TYPES: ZH (Zero housing), APH (Airtight Plaster housing)

CONICAL



4540

Fixed LED, wall wash light - with 2" round flanged or flangeless trim for use as retrofit.

LAMP OPTIONS: Citizen and Ambient Dim LED

HOUSING TYPES: Retrofit

SNAP

Flexible modular design with Bluetooth Technology for smartphone control of SNAP Lighting systems

NEW!

3300-EXT-SN SH



6005-SN-CYL-AC

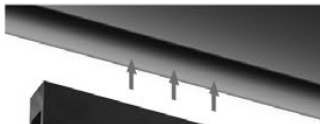

900-SN-FL

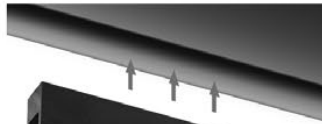

888-SN 10C

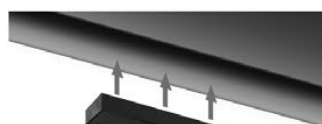

6005-SN-CYL

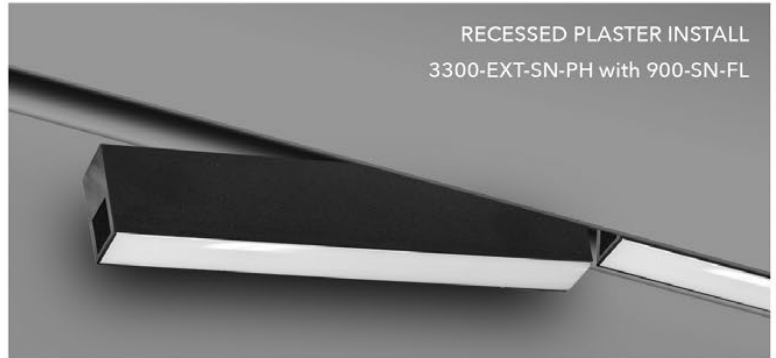

RECESSED PLASTER INSTALL
3300-EXT-SN-PH with 900-SN-FL

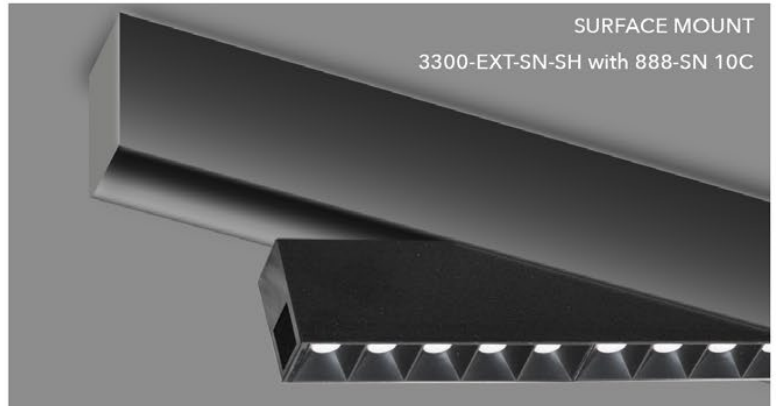

SURFACE MOUNT
3300-EXT-SN-SH with 888-SN 10C



CASAMBI
READY

Activate
with your
Smartphone

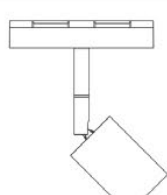

Transmitter

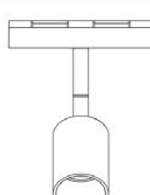

Receiver 1

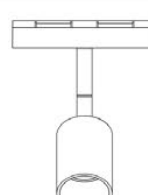

Receiver 2

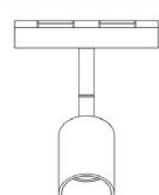

Receiver 3

SERIES LINEAR WALL WASHER

Linear Wall Washers provide smooth washes on wall surfaces. All of our linear products are build-to-order, semi-custom. The fixtures are built to your exact dimensions to create a beautiful, architecturally integrated, wall-to-wall installation. They can be ordered to fit any ceiling system.



600

Multi-lamp, surface mounted linear wall washer with nominal 3.5" (90mm) wide aperture, and cast borosilicate fresnel lens or acrylic lens.

LAMP OPTIONS: LED, T3, T4, T5
HOUSING TYPES: SH Surface housing

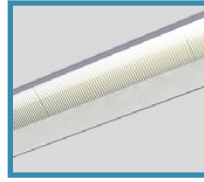

813

Multi-lamp, recessed linear wall washer with nominal 5" (125mm) wide aperture and borosilicate supertex spread lens.

LAMP OPTIONS: MR-11
HOUSING TYPES: FH Flanged housing; Plaster housing; Wood housing



601

Multi-lamp, recessed mounted linear wall washer with nominal 5" (125mm) wide aperture, flanged or flangless trim and acrylic fresnel lens.

LAMP OPTIONS: LED, MR-11, ALR-12, T5
HOUSING TYPES: FH Flanged housing; Plaster housing; Wood housing

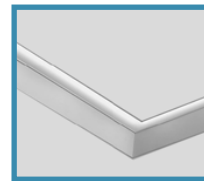

815

Multi-lamp, recessed linear wall washer with nominal 5" (125mm) wide aperture, adjustable socket plate and borosilicate supertex spread lens.

LAMP OPTIONS: MR16, ALR12, Soraa
HOUSING TYPES: PH Plaster Housing, FH Flange housing, WH Wood housing



606

Multi-lamp, surface mounted linear wall washer. Nominal 4" (102mm) wide and 5" (127mm) tall housing with acrylic lens.

LAMP OPTIONS: LED
HOUSING TYPES: SH Surface housing

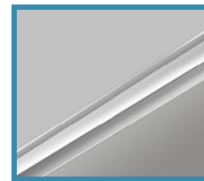

817

Multi-lamp, recessed linear wall washer with nominal 5" (125mm) wide aperture, fixed socket plate and double lensed borosilicate supertex spread lens.

LAMP OPTIONS: MR16, ALR12, Soraa
HOUSING TYPES: PH Plaster Housing, FH Flange housing, WH Wood housing

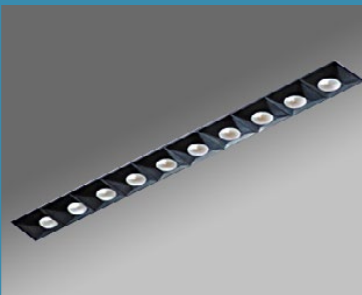

888 « SLICE »

Multi-lamp, solid state light engine, recessed linear wall grazer with flanged (FH) or flangless (PH) housing, nominal 2" wide, baffle and regressed acrylic lens. Integral electronic dimmable driver options.

LAMP OPTIONS: LED
HOUSING TYPES: FH or PH – choice between SM Smooth and SD Stepped baffle type

Available in different configurations

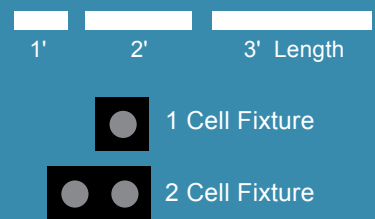

899 « SLICE »

Multi-lamp, solid state light engine, recessed linear wall grazer with flanged (FH) or flangless (PH) housing, nominal 3" wide, baffle and regressed acrylic lens. Integral electronic dimmable driver options.

LAMP OPTIONS: LED
HOUSING TYPES: FH or PH – choice between SM Smooth and SD Stepped baffle type

Available in different configurations

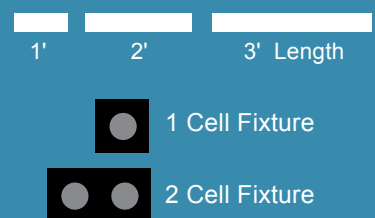

SERIES LINEAR WALL GRAZER

Linear Wall Grazers can also be used in downlighting applications. All of our linear products are build-to-order, semi-custom. The fixtures are built to your exact dimensions to create a beautiful, architecturally integrated, wall-to-wall installation. They can be ordered to fit any ceiling system.

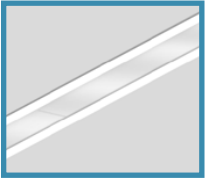

700

Multi-lamp, surface mounted linear wall grazer. Nominal 2.5" wide (64mm) aperture, with acrylic and borosilicate supertex spread lens options.

LAMP OPTIONS: LED

HOUSING TYPES: FH (Flanged), SH (Surface), PH (Plaster)

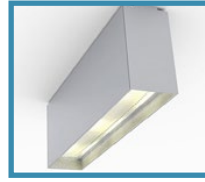

804

Multi-lamp, surface mounted linear wall grazer. Nominal 2" wide aperture, with acrylic and borosilicate supertex spread lens options.

LAMP OPTIONS: LED, MR-11, ALR-12, T5

HOUSING TYPES: SH (Surface), wall mounted or pendant

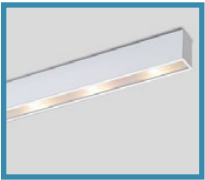

800

Multi-lamp, surface mounted linear wall grazer. Nominal 2" wide (50mm) aperture, with acrylic and borosilicate supertex spread lens options.

LAMP OPTIONS: LED, MR-11, ALR-12.

HOUSING TYPES: SH (Surface), wall mounted or pendant



805

Multi-lamp, recessed linear wall grazer with nominal 1.5" (38mm) to 2" (50mm) wide aperture and regressed acrylic or borosilicate supertex spread.

LAMP OPTIONS: LED, MR-11, ALR-12, T5

HOUSING TYPES: FH (Flanged), PH (Plaster), APH (Airtight plaster frame), AFH (Airtight Flanged).



801

Multi-lamp, recessed linear light slot, nominal 1.5" (35mm) wide aperture and borosilicate aperture lens. May be used as a wall grazer or a general lighting down light. ST trim used in showers or other wet locations. LC used in high vibration applications such as elevator cabs.

LAMP OPTIONS: LED, MR-11, ALR-12.

HOUSING TYPES: FH (Flanged), PH (Plaster), IH (In-floor), APH (Airtight plaster frame), AFH (Airtight Flanged).



811

Multi-lamp, linear wall grazer with nominal 1.5" (38mm), 2" (50mm), 4" (100mm) wide aperture options; veiling acrylic, borosilicate supertex spread lens and pyrex walk over lens options.

Custom curved ceiling options.

LAMP OPTIONS: Xicato LED, AmbientDim, Citizen, ALR-12 (GBD) 20w, MR-16, PAR 20, PAR 30, PAR 38, PAR 30MH, AR111

HOUSING TYPES: FH (Flanged), SH (Surface mount), PH (Plaster), APH (Airtight plaster frame), AFH (Airtight Flanged), WD (Wood) SHI (Surface mounted Inverted), IH (Inverted Uplight),



802

Multi-lamp/Single-lamp, recessed linear light slot with flanged or surface mounted housing, nominal 2.5" (60mm) wide aperture and borosilicate aperture lens. May be used as wall grazer, general down light or up light. Models for wet locations.

LAMP OPTIONS: LED, ALR-12 (GBD) 20w, MR-16 spot, 37w max., Soraa

HOUSING TYPES: FH (Flanged), PH (Plaster frame), SH (Surface)

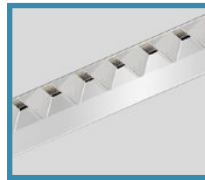

812

Multi-lamp, recessed linear wall grazer with flangless housing, nominal 1.5" (38mm) wide aperture, deep parabolic baffle and raised aperture lens.

LAMP OPTIONS: LED

HOUSING TYPES: PH (Plaster), APH (Airtight plaster frame), SH (Surface).



803

Large or medium profile, linear recessed or surface mounted with socket plate and double lensed unit. Supertex borosilicate glass lens. In-floor up lighting option.

LAMP OPTIONS: LED, MR-16, ALR-12, Soraa, PAR20/30, Metal Halide, AR111

HOUSING TYPES: SH (Surface), Recessed



819

Large profile, recessed, intended to graze down walls and other flat surfaces by positioning the trim of the fixture housing near the surface to be illuminated. Supertex borosilicate glass lens,

plus other options.

LAMP OPTIONS: ALR-12 (GBD), MR-16, Soraa

HOUSING TYPES: PH (Plaster); FH (Flanged housing), WH (Wood Flangeless)

NOTE: These specifications are subject to change without notice

SERIES LINEAR GENERAL

All of our linear products are build-to-order, semi-custom. The fixtures are built to your exact dimensions to create a beautiful, architecturally integrated, wall-to-wall installation.

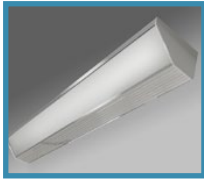

120-LED

Ideal for cove or under cabinet lighting applications, the 120-LED employs a linear, led light engine providing excellent illumination. Extruded aluminum housing with seamless end plates.

LAMP OPTIONS: LED

HOUSING TYPES: Extruded aluminum, surface mounted



415

Small aperture fixed down light used in medium ceiling heights to highlight the texture in surfaces such as stucco or brick, illuminate flat surfaces such as venetian plaster, fabric or wood, or specular surfaces such as polished stone or stainless steel.

LAMP OPTIONS: LED, MR16, ALR12, Soraa

HOUSING TYPES: Extruded aluminum housing with Ultrim™ plaster frame



700

Pendant mounted narrow profile lighting system used in low to medium ceiling heights to illuminate as general lighting. Multi-lamp, linear system, nominal 3" (80mm) wide aperture and acrylic lens.

LAMP OPTIONS: 2700K, 3000K or 3500K LED supplied with fixture, MR16, ALR12

HOUSING TYPES: Pendant mount, extruded aluminum with seamless welded and ground end plates, wall mounted



840

Multi-lamp, up and adjustable down light pendant linear wall grazer with nominal 1.5" (38mm) to 2" (50mm) wide aperture and regressed acrylic lens if required.

LAMP OPTIONS: LED, MR-11, ALR-12, T5, T8

HOUSING TYPES: Pendant mounted, wall mounted



850

Multi-lamp, fixed up/adjustable down light with pendant linear wall grazer with nominal 1.5" (38mm) to 2" (50mm) wide aperture and regressed acrylic lens.

LAMP OPTIONS: 2700K, 3000K or 3500K LED supplied with fixture, MR-11, ALR-12, T5

HOUSING TYPES: Pendant mounted, wall mounted

MOSAIC SERIES LINEAR MULTI-USE

Extruded aluminum accent light housing available as track or recessed to accommodate a large range of linear and point sources. Three circuit wire-way provides power for a wide array of lighting elements that can be located anywhere along the length of the housing. Optional indirect ambient light.



TRK-SH LINEAR TRACK SYSTEM

Track lighting system (TRK) with optional adjustable track head lamps 3610 and 3620. Lighting elements are fully adjustable in both aiming as well as position; easily added or removed in the field to respond to varying architectural conditions. Easily customizable to fit.

LAMP OPTIONS: Citizen, Ambient Dim, Xicato, LED, MR16, Soraa

HOUSING TYPES: SH Surface Housing - Numerous Trim options available
Housing and Lamping components sold separately



1005C LINEAR ACCENT HOUSING

Truly flexible lighting system useful in applications such as museum, retail and residential environments. Lighting elements are fully adjustable in both aiming as well as position; easily added or removed in the field to respond to varying architectural conditions. The 1005C series is a clean, multi-functional tool that allows the designer to create a unified design in a single fixture. Available in various sources for accent and linear elements, various ceiling conditions and customizable.

LAMP OPTIONS: LED, MR16, T3, T5, T8, CMH, AR111, Lumenetix

HOUSING TYPES: PH Plaster, UH Universal - Numerous Trim options available
Housing and Lamping components sold separately



3000 LINEAR ACCENT HOUSING

Useful in applications such as museum, retail and residential environments; the system is totally flexible with lighting elements that may be easily changed in the field to respond to varying architectural conditions. The 3000 series is a tool that allows the designer to create a unified design that is easier to understand and results in a space that is more comfortable to inhabit.

LAMP OPTIONS: Citizen, Xicato and AmbientDim, ALR12, ALR18, MR16, PAR20, PAR30, PAR36, AR111, PAR38, MR16MH, PAR20MH, PAR30MH, PAR38MH T3, T5, T8, Indirect - FC, T3,T4, T5, LED, Lumenetix

HOUSING TYPES: PH Plaster, UH Universal - Numerous Trim options available
Housing and Lamping components sold separately



3500 LINEAR POCKET SYSTEM

The Mosaic pocket system is a combination of linear general lighting with accent lights located in sections or "pockets" strategically placed in the linear fixture. Useful in applications such as museum, retail and residential environments. The 3500 series is a tool that allows the designer to create a unified design that is easier to understand and results in a space that is more comfortable to inhabit.

LAMP OPTIONS: Combinations of LED, fluorescent, low-wattage halogen, metal halide, Lumenetix

HOUSING TYPES: PH (Plaster), UH (Universal linear housing), FH (flanged housing) or Pendant Mounted.

SERIES
WOOD
ADJUSTABLE/FIXED

Customize SLI's standard point source trims from traditional hardwoods. Customers supply the wood and SLI has the resources to sculpt blocks of wood into finished masterpieces that blend wonderfully with matching wood ceilings.



NEW!

1090-2

Oval, 2-lamp LED point source fixtures are available with many different light sources. Nominal 4" x 9" and optional glass diffuser. Interchangeable reflector provides multiple beam patterns. Optional borosilicate lenses available for aperture.

LAMP OPTIONS: Citizen, Xicato, AmbientDim®, MR-16
HOUSING TYPES: WH Wood

FLAT



1000 / 4000

Round, single point source fixtures are available with many different light sources. Nominal 4" (102mm) diameter flat trim with 2" aperture and optional glass diffuser. Interchangeable reflector provides multiple beam patterns. Optional borosilicate lenses available for aperture.

LAMP OPTIONS: Citizen, Xicato, AmbientDim®, MR-16, MR-16 CMH, Soraa, AR111, Lumenetix

HOUSING TYPES: WH Wood

CONICAL



1001 / 4001

Round, single point source fixtures are available with many different light sources. Nominal 4" (102mm) conical trim with 2" aperture and optional glass diffuser. Interchangeable reflector provides multiple beam patterns. Optional borosilicate lenses available for aperture.

LAMP OPTIONS: Citizen, Xicato, AmbientDim®, MR-16, MR-16 CMH, Soraa, AR111, Lumenetix

HOUSING TYPES: WH Wood

BEVEL



1009 / 4009

Square, single point source fixtures are available with many different light sources. Nominal 4" square trim and optional glass diffuser. Interchangeable reflector provides multiple beam patterns. Optional borosilicate lenses available for aperture.

LAMP OPTIONS: Citizen, Xicato, AmbientDim®, MR-16, MR-16 CMH, Soraa, AR111, Lumenetix

HOUSING TYPES: WH Wood

FLAT



1012 / 4012

Square, single lamp point source fixtures are available with many different light sources. Nominal 4" flat square trim, flanged or flangeless trim and optional glass diffuser. Interchangeable reflector provides multiple beam patterns.

Optional borosilicate lenses available for aperture.

LAMP OPTIONS: Citizen, Xicato, AmbientDim®, MR-16, MR-16 CMH, Soraa, AR111, Lumenetix

HOUSING TYPES: WH Wood

CONICAL



1016 / 4016

Round, single point source fixtures are available with many different light sources. Nominal 4" (102mm) conical trim with 3" aperture and optional glass diffuser. Interchangeable reflector provides multiple beam patterns. Optional borosilicate lenses available for aperture.

LAMP OPTIONS: Citizen, Xicato, AmbientDim®, MR-16, MR-16 CMH, Soraa, AR111, Lumenetix

HOUSING TYPES: WH Wood

BEVEL



1017 / 4017

Square, single lamp point source fixtures are available with many different light sources. Nominal 4" square trim, flanged or flangeless trim and optional glass diffuser. Interchangeable reflector provides multiple beam patterns. Optional borosilicate lenses available for aperture.

LAMP OPTIONS: Citizen, Xicato, AmbientDim®, MR-16, MR-16 CMH, Soraa, AR111, Lumenetix

HOUSING TYPES: WH Wood

NOTE: These specifications are subject to change without notice

1306 DORIS AVE. OCEAN, NJ 07712 USA
800.462.7812 | 732.517.0800 | F: 732.517.0971
© 2017 SpecialtyLighting Industries, Inc.

www.specialtylightingindustries.com

SERIES WOOD MULTI ADJUSTABLE/FIXED

Multi Adjustable/Fixed point source lighting is used in applications where more lighting is needed than the standard single lamp point source fixtures. Wood trims require WH housing.

BEVEL

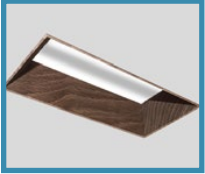

1009-2 / 4009-2

Rectangular, 2-lamp point source fixture are available with many different light sources. Nominal 4" x 9" rectangular trim and optional glass diffuser. Interchangeable reflector provides multiple beam patterns. Optional borosilicate lenses available for aperture.

LAMP OPTIONS: Citizen, Xicato, AmbientDim®, MR-16, MR-16 CMH, Soraa, AR111, Lumenetix

HOUSING TYPES: WH Wood

BEVEL



1017-2 / 4017-2

Rectangular, 2-lamp point source fixture are available with many different light sources. Nominal 4" x 9" rectangular trim, wide aperture and optional glass diffuser. Interchangeable reflector provides multiple beam patterns. Optional borosilicate lenses available for aperture.

LAMP OPTIONS: Citizen, Xicato, AmbientDim®, MR-16, MR-16 CMH, Soraa, AR111, Lumenetix

HOUSING TYPES: WH Wood

SERIES WOOD STEP LIGHTS

Step light is a recessed luminaire with a regressed slot aperture to control glare. The light source is available in 2W or 4W AC, TRIAC dimmable white light emitting diode. Wood trims require WH housing.

NEW!

2101



Recessed Step Light for applications in step or path lighting. Rugged construction with various housings for integration in most conditions.

Available in a 2 watt or 4 watt LED source.

Dimming and colored lens options available.

LAMP OPTIONS: LED, 3000K

HOUSING TYPES: WH Wood, FH Flanged

NEW!

2102



Recessed Step Light with shielded source for applications in step lighting. Rugged construction with various housings for integration in most conditions. Available in a 2 watt or 4 watt LED

source. Dimming and colored lens options available.

LAMP OPTIONS: LED, 3000K

HOUSING TYPES: WH Wood, FH Flanged

SERIES POINT SOURCE WALL WASHER

All of our wall washers are specification grade, can be built to specification. SLI wall washers provide clean, even and total coverage for applications that demand superior lighting. Wood trims are machine cut to tight tolerances

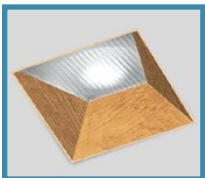

1240

The 1240-2 wall wash fixtures are designed optically to flood the surface of the wall with light from the ceiling line to the floor. They can be ordered to fit any ceiling system. Single lamp recessed wall washer with nominal 4" square aperture.

Frosted supertex borosilicate spread lens, hinged for relamping.

LAMP OPTIONS: Citizen, Xicato, AmbientDim, MR-16, MR-16 CM, Soraa, Lumenetix

HOUSING TYPES: WH Wood



1250

The 1250 round wall wash fixture is designed optically to flood the surface of the wall with light from the ceiling line to the floor. They can be ordered to fit any ceiling system. Single lamp,

recessed wall washer with nominal 4" diameter. Frosted supertex borosilicate spread lens, hinged for relamping.

LAMP OPTIONS: Citizen, Xicato, AmbientDim, MR-16, MR-16 CMH, Soraa, Lumenetix

HOUSING TYPES: WH Wood

Source Unknown **HUSH-3**[®] Silent Ceiling
Glare-Free design



LENS RELECTOR FINISHES

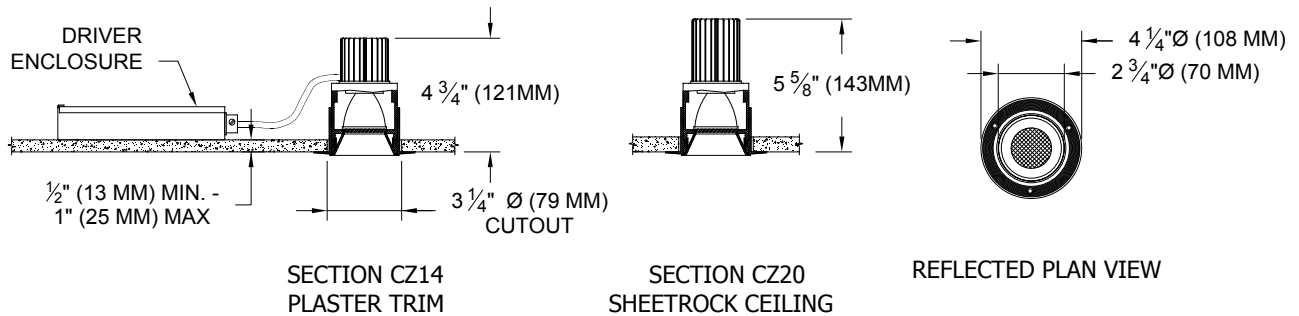

NEW!
HUSH-3

Recessed cylinder, single lamp LED point source fixtures with nominal 3" (70mm) aperture and conical trim. Special design allows for easy lamp removal. Lens reflectors are available in a variety

of stylish colors.

LAMP OPTIONS: Citizen, AmbientDim[®]

HOUSING TYPES: PH Plaster Housing, FH Flanged Housing

NOTE: These specifications are subject to change without notice

1306 DORIS AVE. OCEAN, NJ 07712 USA
800.462.7812 | 732.517.0800 | F: 732.517.0971
© 2017 SpecialtyLighting Industries, Inc.

www.specialtylightingindustries.com

Patent Pending
3/18



flawless.

SERIES
SPECIALTY
ADJUSTABLE MULTI-LAMP

NEW!
1602 / 1652

1, 2, or 4 lamp, solid state light engine, with 24" square or rectangular options. Each lamp has a gimbal mechanism for maximum adjustability. T-bar installation for 1602 and pendant mount install for 1652.

LAMP OPTIONS: Citizen, Xicato, LED, MR-16, Soraa

HOUSING TYPES: SH (Surface Housing), Recessed, Pendant

LAYOUT OPTIONS: A1 (1 lamp sq), B2 (2 lamp sq), C4 (4 lamp sq), D1 (1 lamp sq), E2 (2 lamp sq)

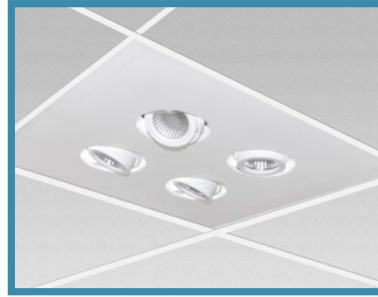

1602 - T-bar install



1652 - Pendant Mount install

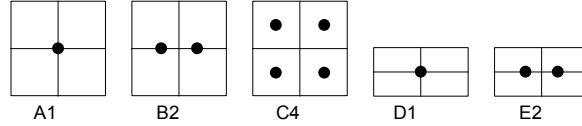

SERIES
CYLINDER
SURFACE MOUNTED/PENDENT

Sleek architectural high performing 4" and 6" diameter cylinders that deliver maximum output. Available in surface mounted or pendant mounting configurations.



4018

Single lamp, solid state light engine, surface mounted down light with nominal 4" (100mm) or 6" (150mm) aperture.

LAMP OPTIONS: Citizen, Xicato, AmbientDim®

HOUSING TYPES: Heavy wall extruded alum. tube with machined adjustable ceiling collar, cable, pendant, wall mounted



1218

Single lamp, solid state light engine, surface mounted wall wash light.

LAMP OPTIONS: Citizen, Xicato, AmbientDim

HOUSING TYPES: Heavy wall extruded aluminum tube with machined adjustable ceiling collar



1018 NEW!

Cylinder, single lamp point source fixtures with 4" (50mm) housing and conical trim. Stackable options with Long Snoot and surface mounted junction box. Modular housing allow for 360° rotation along the horizontal plane and 90° rotation across the vertical.

LAMP OPTIONS: Citizen, AmbientDim®

HOUSING TYPES: SH Surface housing, pendant mounted



4700

Single lamp, Surface Mounted fixed downlight, 2.25" aperture and optional Cable (CM) or Pendant Mount (PM). Narrow 12" cylindrical housing creates a visual presence for low to medium ceilings heights in residential, commercial and retail environments.

LAMP OPTIONS: Citizen, Xicato, AmbientDim

HOUSING TYPES: SH Surface housing, pendant, cable, wall mounted

SERIES
SPECIALTY
3-STAGE DOWN LIGHT

2505

Single lamp, solid state light engine, recessed 2" (50mm) aperture down light and accent light. Flood aperture with low brightness parabolic reflector. Retractable for different field conditions.

LAMP OPTIONS: LED, MR-16, Soraa

HOUSING TYPES: PH (Plaster for Flangeless)



Stage 1- Fully-Recessed

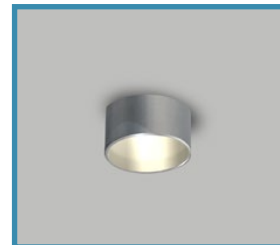

Stage 2- Semi-Recessed



Stage 3-Full Extension*



*Stage 3-Full Extension provides multi-directional capability
180° Degree rotation / Fully retractable

SERIES POINT SOURCE UP LIGHTS

Up light accent lights are designed to mount into exterior hard surfaces (not for in soil mounting). They give you adjustability and outdoor use.

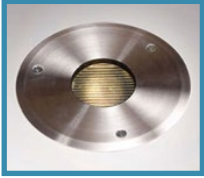

2001/2002 Round

SLI up light accent lights are designed to mount into floor. Provides for slight adjustability. 4" round trim (2001) or 6" round trim (2002), Supertex borosilicate glass and clear Pyrex protective cover.

LAMP OPTIONS: LED, MR-16

HOUSING TYPES: IH (Inverted Housing).

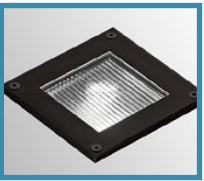

2003/2004 Square

SLI up light accent lights are designed to mount into floor. Provides for slight adjustability. 4" or 6" square trim options, Supertex borosilicate glass and clear Pyrex protective cover.

LAMP OPTIONS: LED, MR-16

HOUSING TYPES: IH (Inverted Housing)

SERIES STEP LIGHTS

Step light is a recessed luminaire with a regressed slot aperture to control glare. The light source is available in 2W or 4W AC, TRIAC dimmable white light emitting diode.

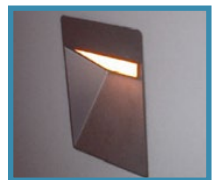

2101

Recessed Step Light for applications in step or path lighting. Rugged construction with various housings for integration in most conditions. Available in a 2 watt or 4 watt LED source. Dimming and colored lens options available.

LAMP OPTIONS: LED, 3000K

HOUSING TYPES: PH Plaster Flange, FH Overlap Flange housing, CH concrete housing, WH Wood housing



2102

Recessed Step Light with shielded source for applications in step lighting. Rugged construction with various housings for integration in most conditions. Available in a 2 watt or 4 watt LED.

Dimming and colored lens options available.

LAMP OPTIONS: LED, 3000K

HOUSING TYPES: PH Plaster Flange, FH Overlap Flange housing, CH concrete housing, WH Wood housing



- Client: Neiman Marcus
- Location: Miami, Florida
- Lights: 2102 Steplights

SERIES PICTURE LIGHTS

The picture light series are architecturally designed to be beautiful addition to any decor. These crafted fixtures are used to light fine art, wall murals, or as a wash of light on any surface. Painted and metallic finishes available.



201

Small profile art lighting designed to evenly illuminate standard size works of art (up to 6' tall.) Can also be used as indirect ceiling/cove lighting. Brass and Aluminum finishes available.

LAMP OPTIONS: LED, 5W-T3, 10W-T3, 20W-T4

HOUSING TYPES: Cord & plug, J-box, Through panel, Desk/lectern, End swivel



204

Medium profile art lighting designed to evenly illuminate standard size works of art (up to 6' tall.) Can also be used as indirect ceiling/cove lighting. Brass and Aluminum finishes available.

LAMP OPTIONS: LED, 20W-T4, T3 (remote transformer req)

HOUSING TYPES: Cord & plug, J-box, Through panel, Desk/lectern, End swivel



206

Art lighting designed to evenly illuminate standard size works of art (up to 6' tall.) Can also be used as indirect ceiling/cove lighting.

LAMP OPTIONS: 20W-T4, T3 (remote transformer req)

HOUSING TYPES: Cord & plug, J-box, Through panel, Desk/lectern, End swivel



303

The 303 series has a sophisticated optical system designed to light larger surfaces up to 12 feet (4M) tall. These crafted fixtures are used to

light fine art, wall murals, or as a wash of light on any surface.

Painted and metallic finishes available. Multi-lamp, low-voltage halogen, extruded picture light with nominal 3" (75mm) wide elliptical housing. Supertex, acrylic lens.

LAMP OPTIONS: LED, MR-11 (FSS) narrow spot

HOUSING TYPES: Cord & plug, J-box, Through panel, Desk/lectern, End swivel



304

The 304 series has a sophisticated optical system designed to light larger surfaces up to 12 feet (4M) tall. These crafted fixtures are used to light fine art, wall murals, or as a wash of light on any surface. Painted and metallic finishes available. Multi-lamp, low-voltage halogen, extruded picture light with nominal 3½" (89mm) wide tubular housing. Molded borosilicate spread lens.

LAMP OPTIONS: LED, MR-11 (FSS) narrow spot

HOUSING TYPES: Wall or frame, J-box, Through panel, End swivel



306

Provides smooth even illumination of surfaces up to 12 feet (4M) tall. May be used to light large pieces of art light such as tall painting or murals. May also be used to illuminate shelving or indirectly light ceilings. Multi-lamp, solid state light engine with nominal 3" (75mm) wide elliptical housing and integral backshield.

LAMP OPTIONS: LED, MR-11 (FSS) narrow spot

HOUSING TYPES: Extruded aluminum with seamless welded and ground end plates



SLI Commitment to Quality

Providing Essential Lighting for All

Proudly Assembled in U.S.A.

www.specialtylightingindustries.com

eldoLED®
your product | our drive

AmbientDim™

CITIZEN
Micro HumanTech

LUTRON®

lumenetix®

WORKS WITH
SRAA®

XICATO®